

Minimum Two
Persons Assembly



DELPHINE 3 DRAWER BEDSIDE CABINET
STK779204

Assembly Instructions

Please keep these instructions for future reference.

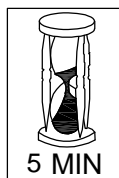

Approximate
Assembly Time

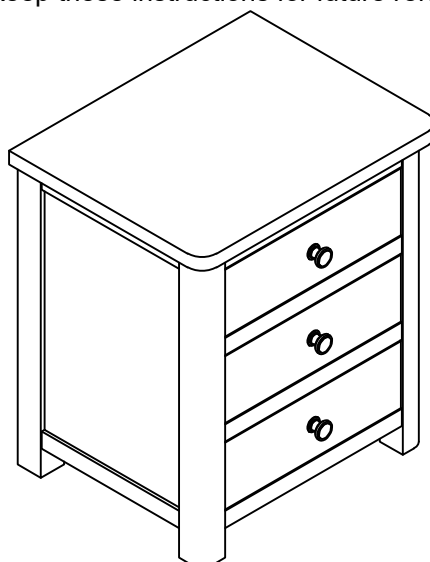

Regrettably self-assembly items can not be returned once assembly is part or fully completed unless the items are found to be faulty. Should you need to return the unassembled product, please repack in its original packaging.

Important Information

- We suggest you spend a short time reading through this leaflet and then follow the simple step-by-step instruction.
- Carefully check that you have all the parts before beginning assembly.
- Keep fittings out of children's reach and keep children well away from construction area.
- We suggest you retain these instructions for future reference.
- In the unusual event of an issue with your product would you please quote the batch I.D. number situated on the main parts of the frame.





Product Information

- 3 Drawer Bedside Cabinet.
- Product finished in light Oak colour using Oak and Oak Veneers.

Care Instructions

- Avoid exposing the furniture to excessive heat or direct sunlight as this can cause cracking and deterioration of color
- Periodically dust lightly with a clean soft cloth.
- Do not use silicone based furniture polish.
- Any spills should be removed immediately with a damp cloth.
- TAKE CARE WHEN MOVING THE FURNITURE AND NEVER DRAG THE PIECES ACROSS THE FLOOR, AS THIS WILL CAUSE DAMAGE TO THE JOINTS.

DELPHINE 3 DRAWER BEDSIDE CABINET

Component			
	DELPHINE 3 DRAWER BEDSIDE CABINET x 1		
Hardware List			
(A) Strap X 1	(B) M4x20 Screw X 2	(C) Bracket X 2	
			

WARNING

WE SUGGEST THIS ITEM TO BE FIXED TO A WALL FOR SECURITY

Please read these assembly instructions carefully as failure to adhere and non use of the brackets may cause the product to move and possible lead to damage and/or injury if improperly fitted. If in doubt consult a qualified technician.

1. Place the unit into required position.
2. Ensure unit is level before securing to the wall.
3. Attach a bracket (C) to the Cabinet back frame under the top with the short screw (B) provided.
4. Attach a bracket (C) to the wallboard with the long screws (not provided).
5. Move the Cabinet into its final position. Thread a strap (A) through the bracket (C) as shown in the below illustration, tighten strap (A) until snug. Do not over tighten.
6. Make sure the bracket (C) is firmly attached to the wallboard and Cabinet and the strap (A) is snug
7. Please note that wall fixings such as wall plugs are not supplied - please secure the unit to the wall using the appropriate fixings for your wall type. These will be readily available from your DIY/home improvement store.

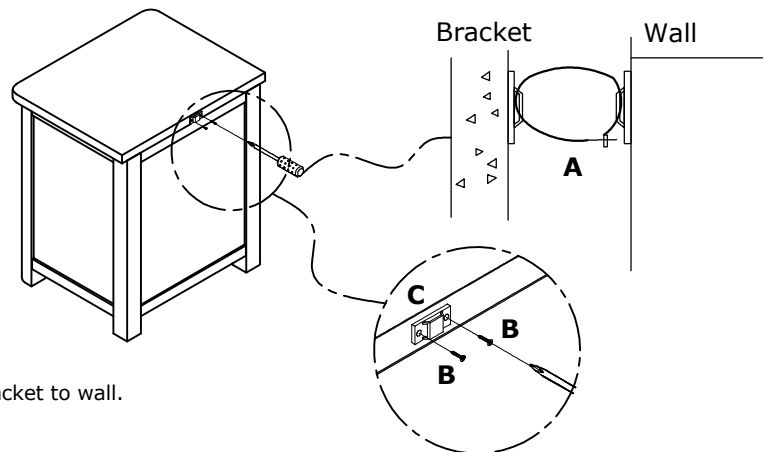
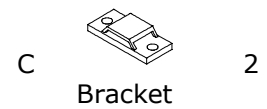

FINAL Step: Attach anti tilt strap or bracket to wall.

WARNING:

To prevent your furniture from tilting forward and possibly causing property damage or personal injury it is recommended that you **Securely attach the anti-tilt straps or brackets provided to your wall using appropriate fixings**

IMPORTANT:

- **DO NOT** place toys or other child appealing items on top of this furniture
- **AVOID** fully opening all drawers at the same time
- **DO NOT ALLOW** small children to climb onto drawers, shelves or to swing from open doors

CAUTION:

For your safety when attaching the anti-tilt fixings;

- Check for any electrical wires or plumbing inside the wall before drilling any holes (if you are unsure please seek professional advice from a qualified tradesman)
- Walls are constructed from different materials eg; Masonry (solid brick) or plaster board lined cavity walls (hollow).

It is important that you use the appropriate wall fixings for your wall type

(Your local hardware store will have the necessary drills and fixings and can offer advice if needed)