

Attention
Two Person Assembly
Needed

Claudia Ottoman Bed

135cm STK806701, 150cm STK806703, 180cm STK806705

135cm STK806702, 150cm STK806704, 180cm STK806706

Assembly Instructions

Please keep these instructions for future reference.



120 mins

Approximate
Assembly time

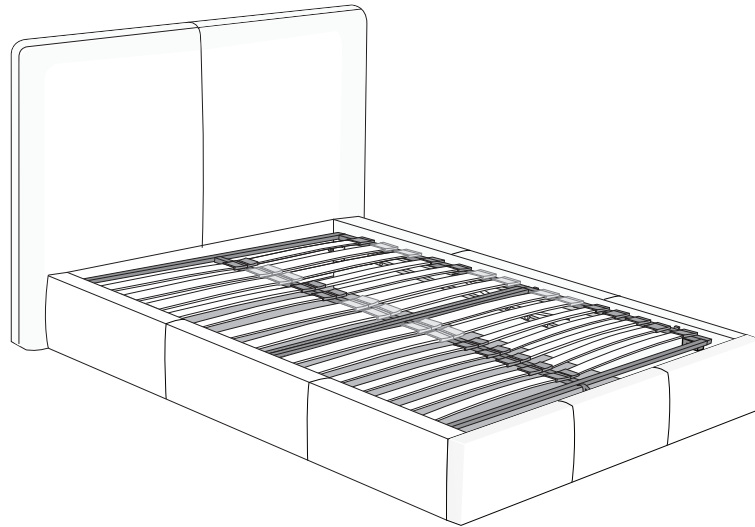

Self-assembly items cannot be returned once assembly is part or fully completed unless the items are found to be faulty. Should you need to return the unassembled product, please repack in its original packaging.

Important Information

- We suggest spending a short time reading through this leaflet and then follow the simple step-by-step instructions.
- Carefully check that you have all the parts before beginning assembly.
- Keep fittings out of children's reach and keep children well away from construction area.
- We suggest retaining these instructions for future reference.











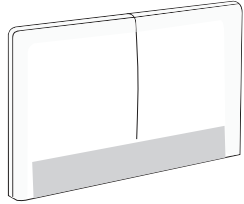
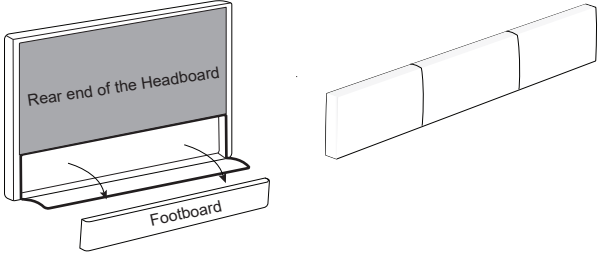

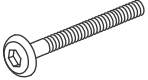
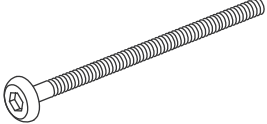
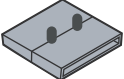
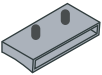
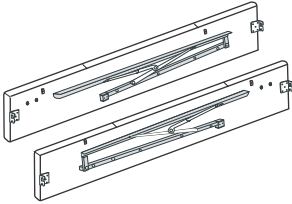
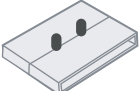
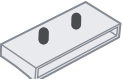

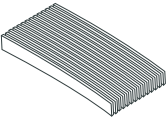
Product Information

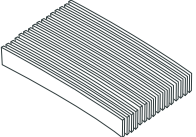
- Conforms to BS EN 1725 Frame.
- Conforms to BS EN 5852 Fabrics and Fillings.
- The maximum weight your mattress can be for this bed is 65kg.

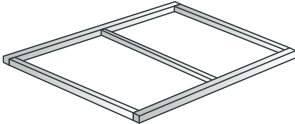

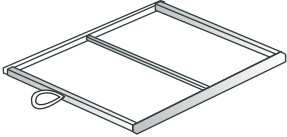

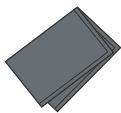
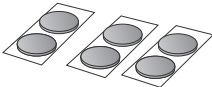





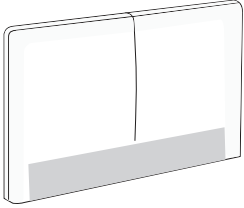
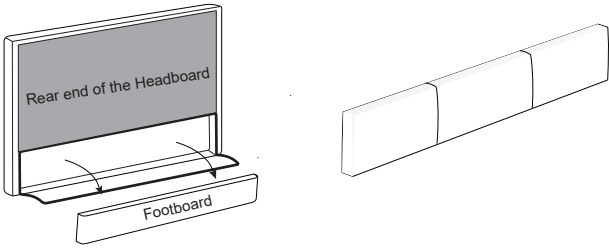

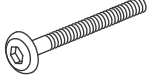
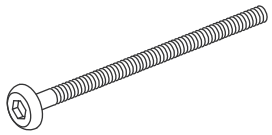
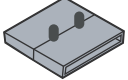

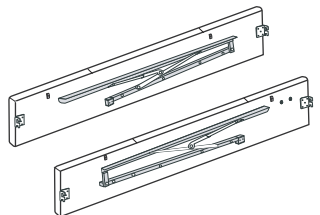
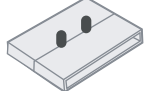
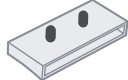

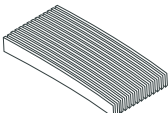
Care Instructions

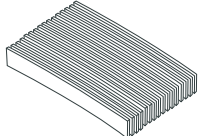
- Avoid exposing the furniture to excessive heat or direct sunlight as this can cause cracking and deterioration of the colour.
- Periodically check & re-tighten all fixings.
- Periodically dust lightly with a clean soft cloth.
- Any spills should be removed immediately with a damp cloth.
- TAKE CARE WHEN MOVING THE FURNITURE AND NEVER DRAG THE PIECES ACROSS THE FLOOR, AS THIS WILL CAUSE DAMAGE TO THE JOINTS.

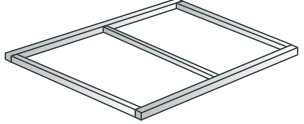
Double size / 135cm x 190cm

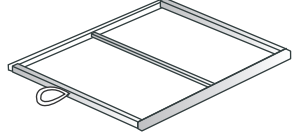
Component of Carton A	Hardware List (In Carton C)
<p>(1) Headboard x 1 </p> <p>(2) Footboard x 1: (Located in the rear end of the Headboard)</p> 	<p>(A) M4 Allen Key x 2 </p> <p>(B) M5 Allen Key x 1 </p> <p>(C) M6 x 45mm x 4 </p> <p>(D) M6 x 70mm x 6 </p> <p>(E) Centre Caps x 8 </p>
<p>Component of Carton B</p>	<p>(F) Side Caps x 16 </p>
<p>(3) Siderails x 2 </p>	<p>(G) Wide Centre Slats Caps x 6 </p> <p>(H) Wide Side Slats Caps x 12 </p>
<p>Component of Carton C</p>	<p>(I) M6 Washer x 16 </p>
<p>(4) Slats x 16 </p>	<p>(J) M6 JCN Nut x 4 </p>
<p>(5) Wide Slats x 12 </p>	<p>(K) M6 Lock Nut x 6 </p>
<p>(6) Metal Head End </p>	<p>(L) M10 Spanner x 1 </p> <p>(M) M13 Spanner x 1 </p>
<p>(7) Metal Foot End </p>	<p>(N) M6 Spring Washer x 6 </p>
<p>(8) Non-woven Fabric x 1 </p>	<p>(O) Felt pad x 6 </p> <p>(P) L-Bracket x 3 </p>

King size / 150cm x 200cm & Super King / 180cm x 200cm

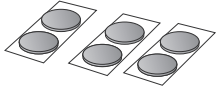
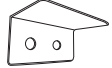
Component of Carton A	Hardware List (In Carton C)
<p>(1) Headboard x 1</p>  <p>(2) Footboard x 1: (Located in the rear end of the Headboard)</p> 	<p>(A) M4 Allen Key x 2 </p> <p>(B) M5 Allen Key x 1 </p> <p>(C) M6 x 45mm x 4 </p> <p>(D) M6 x 70mm x 6 </p> <p>(E) Centre Caps x 10 </p>
<h3>Component of Carton B</h3>	<p>(F) Side Caps x 20 </p>
<p>(3) Siderails x 2</p> 	<p>(G) Wide Centre Slats Caps x 6 </p> <p>(H) Wide Side Slats Caps x 12 </p>
<h3>Component of Carton C</h3>	<p>(I) M6 Washer x 16 </p>
<p>(4) Slats x 20</p> 	<p>(J) M6 JCN Nut x 4 </p>
<p>(5) Wide Slats x 12</p> 	<p>(K) M6 Lock Nut x 6 </p>
<p>(6) Metal Head End Section x 1</p> 	<p>(L) M10 Spanner x 1 </p>
<p>(7) Metal Foot End Section x 1</p> 	<p>(M) M13 Spanner x 1 </p> <p>(N) M6 Spring Washer x 6 </p>
<p>(8) Non-woven Fabric x 1</p> 	<p>(O) Felt pad x 6 </p> <p>(P) L-Bracket x 3 </p>

Tips before you start!

1. Please check that all parts are present before you start the assembly of furniture.
2. For ease and speed of assembly, we recommend that before you commence each step of the assembly, that you identify all the parts required for that step.
3. For larger items, please ensure that you have sufficient space and people (as indicated on page 1) to assemble your product safely. (Minimum Two Persons)
4. We recommend where possible, all items are assembled near to the area where they will be placed in use, to avoid moving the product unnecessarily once assembled.
5. Please ensure that your bed is placed on a level floor area. Avoid setting up and installing your bed on an uneven floor surface.
6. For the protection of your furniture, we recommend that the product is placed on a protected surface during assembly to prevent any damage.
7. During assembly please take care not to over-tighten any fittings, as this may damage the product.



Care and Maintenance of your Furniture

1. Please periodically check all fittings and re-tighten as necessary.
2. To clean your item, please use a soft damp cloth and wipe clean.
3. Please do not jump on your furniture.
4. Never allow any kind of liquid to remain on your furniture. This can cause finishes to de-laminate. Take care when spraying perfume and deodorants etc as the vapour can settle on fabric surface and cause damage.
5. It is important to never drag your bed as this can cause damage to the joints and the fixings. This may invalidate your guarantee.
- 6. The bed should always be lifted into position never dragged or pushed.**

Step 1

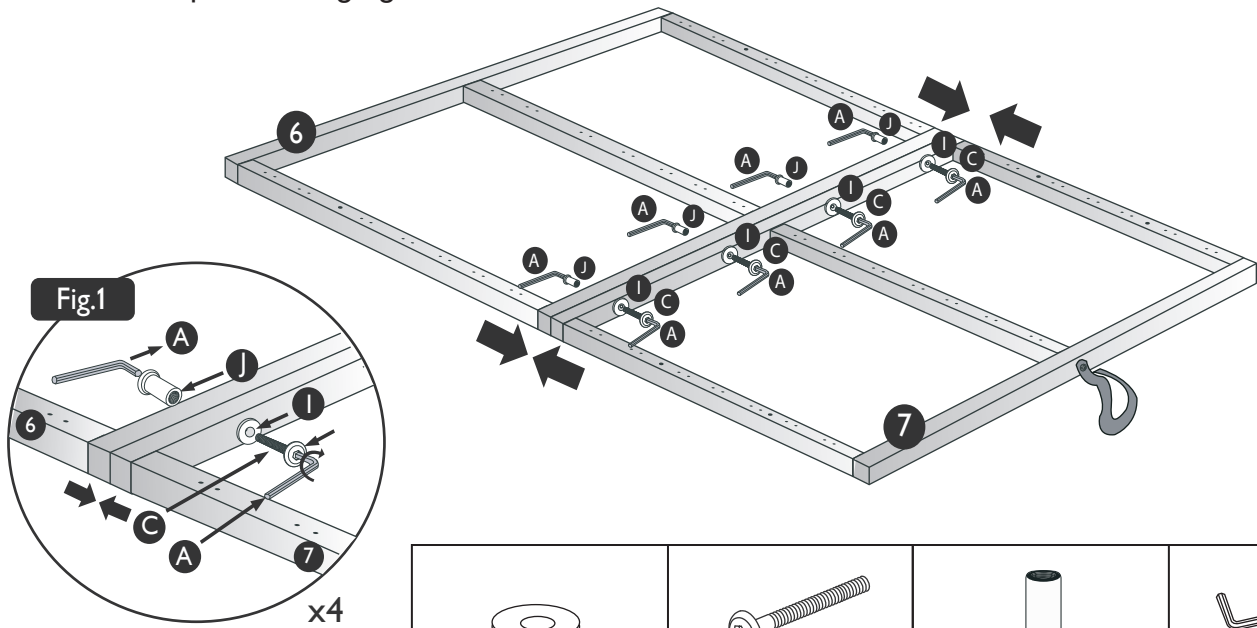
Attach Metal Head End Section (6) and Metal Foot End Section (7) using M6 JCN Nut (J), M6 Washer and M6 x 45mm (C) and tighten with M4 Allen Key (A).
Follow the step according figure 1.

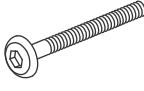

 <p>M6 Washer I x 4pcs</p>	 <p>M6 x 45mm C x 4pcs</p>	 <p>M6 JCN Nut J x 4pcs</p>	 <p>M4 Allen Key A x 2pcs</p>
--	--	---	---

Step 2

Remove the Foot End (2) from the rear of the Head End (1) compartment. Loosen the pre-inserted bolts in the head and footboards (DO NOT REMOVE THEM). Slide metal side rail brackets over the pre-inserted bolts in the head and footboards as shown. Do not fully tighten at this point.

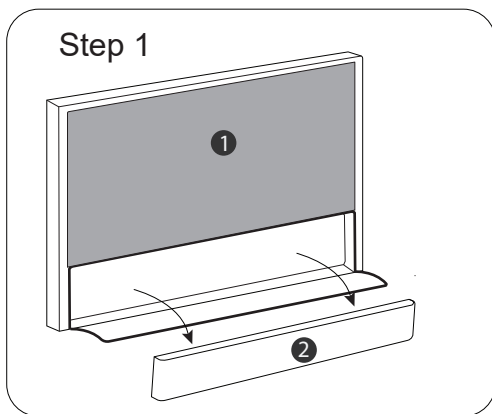

Rear View

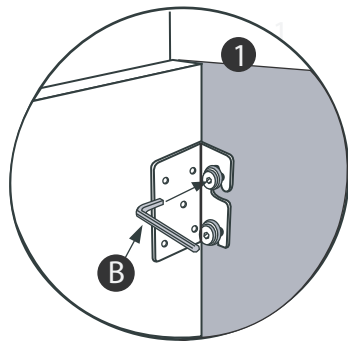

Step 2

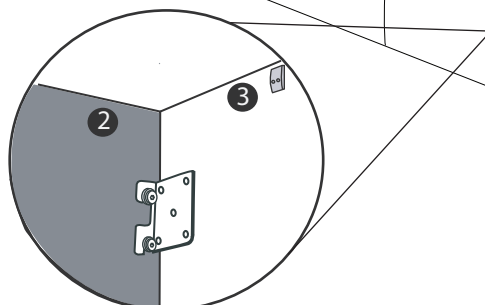
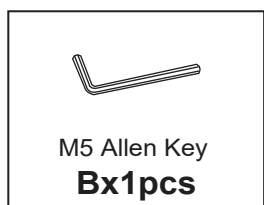
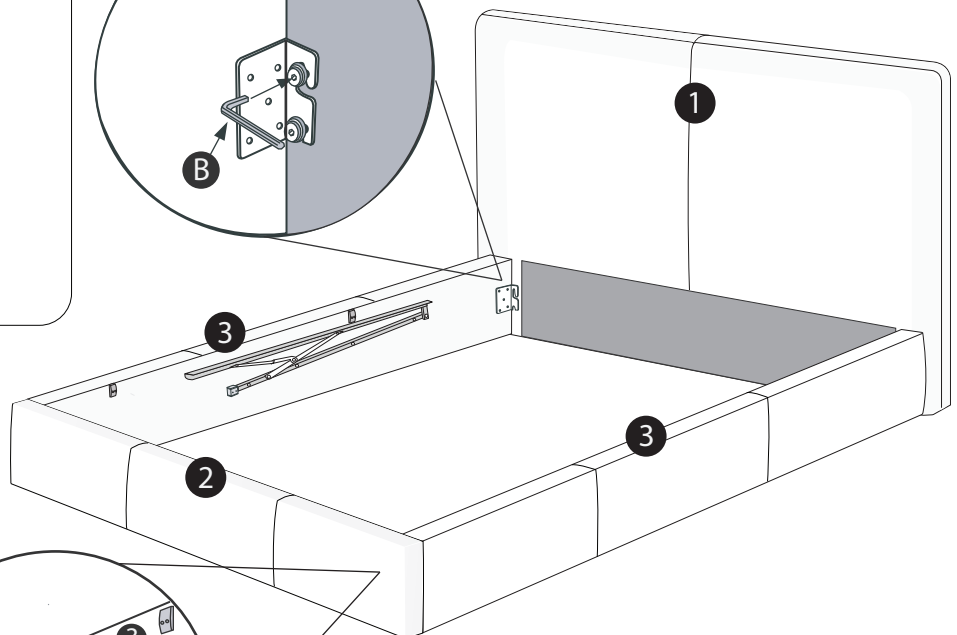

Step 3

Attach the Non-Woven Fabric x 1 pcs (8) to the associated velcro strips on the Head End (1), Foot End (2) and Side Rails (3).

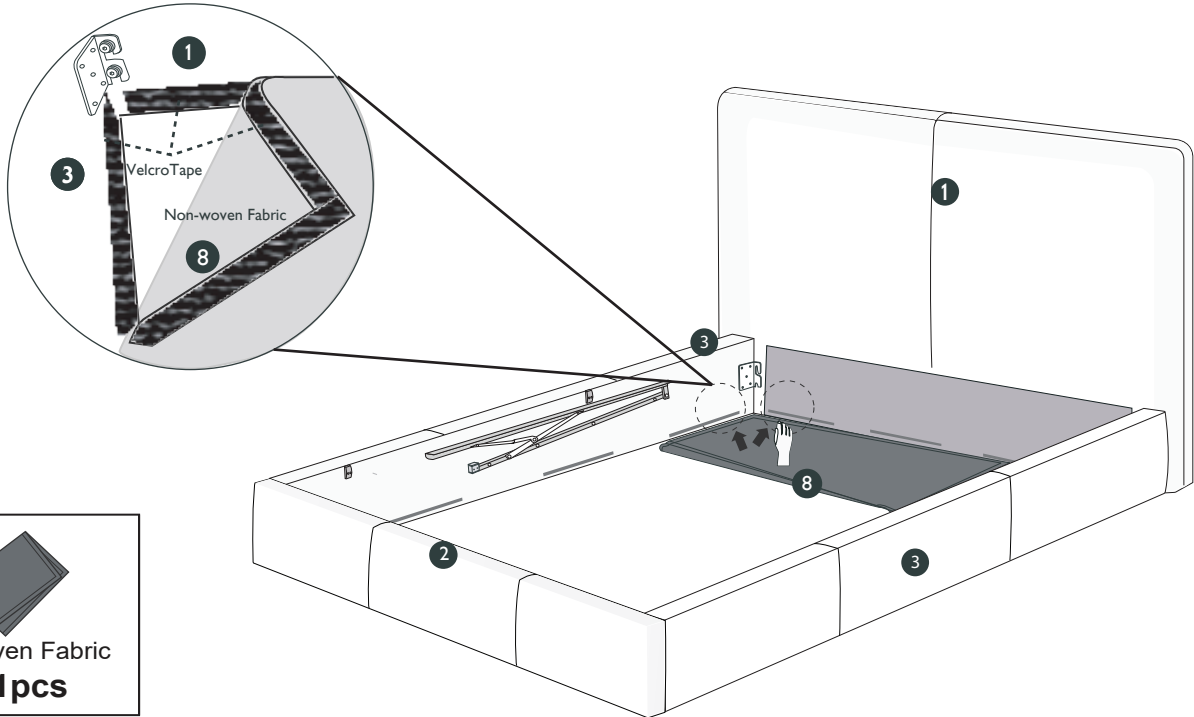

Step 4

Follow the diagram below, take out the pre-inserted bolt and washer on Footboard (2) and Side Rails (3) and attach the L-Bracket (P) by re-inserting the bolt and washer. Tighten with M4 Allen Key (A).

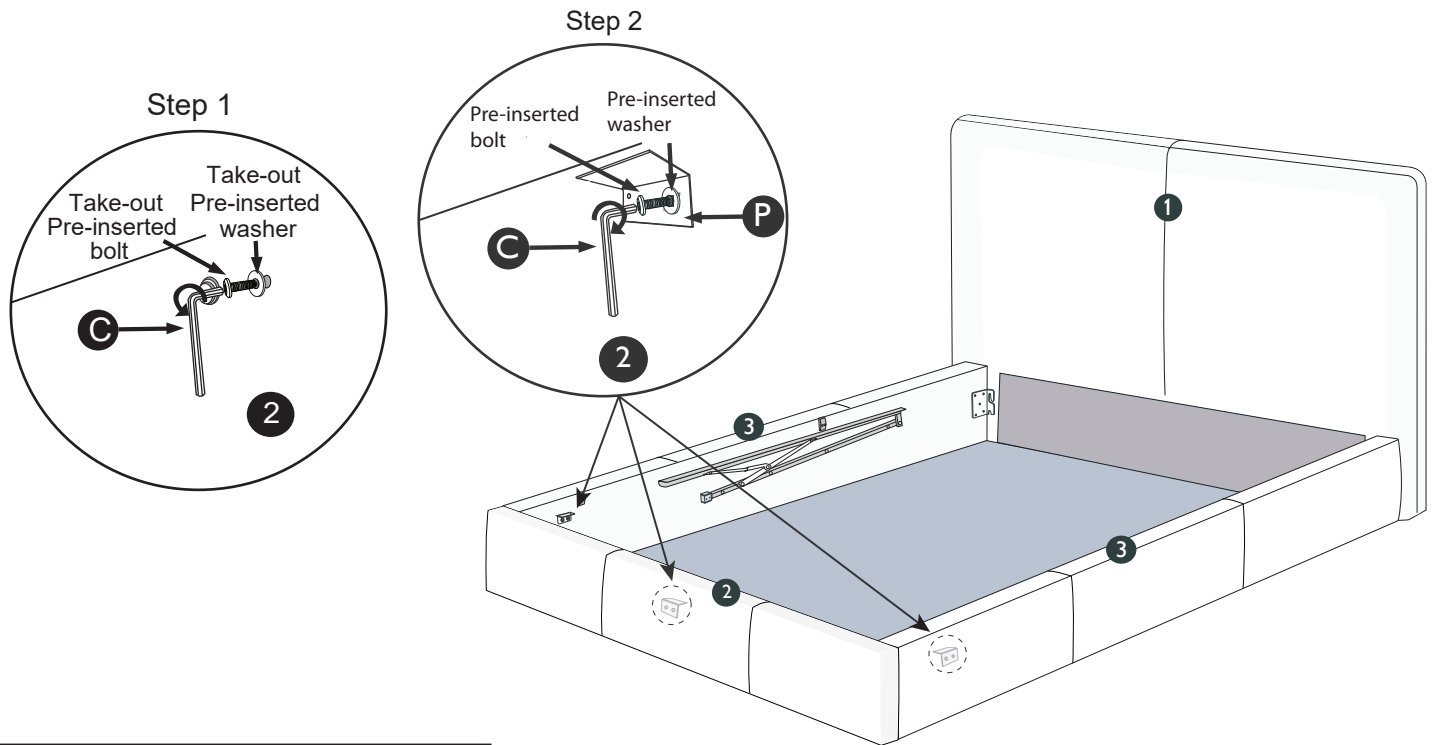

Step 5

Attach the Slatted Base (6) & (7) to the ottoman mechanism using M6 x 70mm (D), M6 Washer (I) x 2, M6 Spring Washer (N) and M6 Lock Nut (K). Insert M6 x 70mm (D) and M6 Washer (I) into the pre drilled holes and secure underneath using M6 Washer (I), M6 Spring Washer (N) and M6 Lock Nut (K). Tighten using M4 Allen Key (A) and the M10 Spanner (L) as shown in diagram 2.

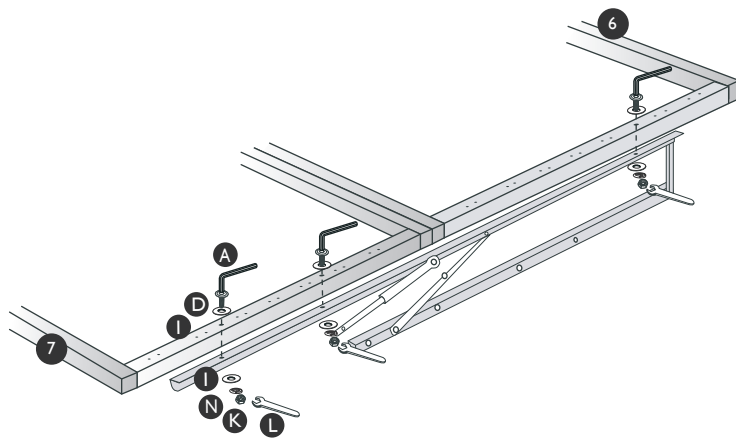
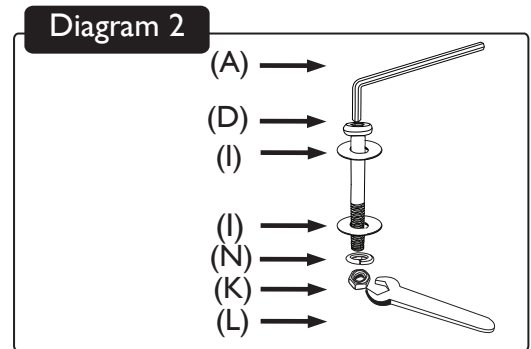
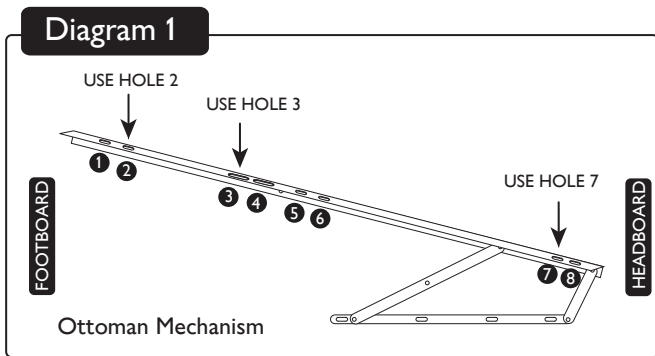

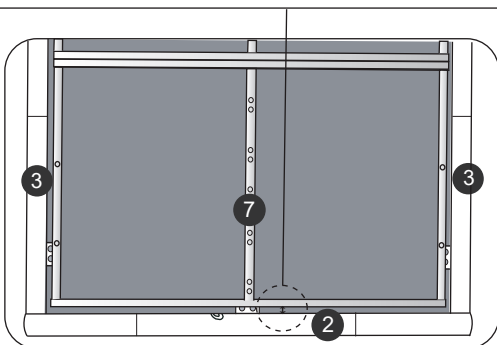

Please note!!

Do not fully tighten the bolts at this stage. Only fully tighten when the frame is in it's final position, with a 3 to 3.5cm gap between the Metal Frame (7) and the Footboard (2).

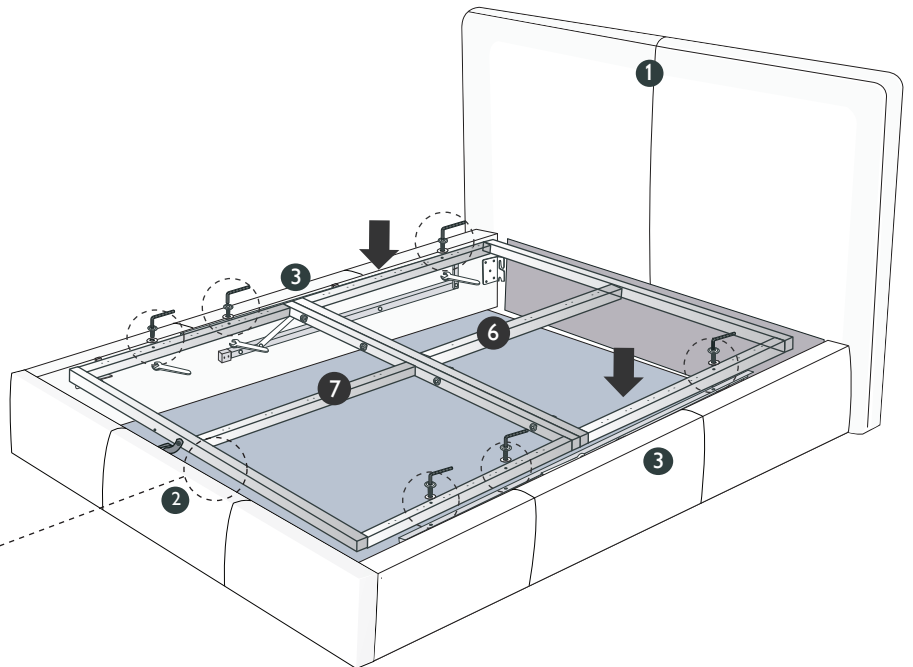

Top View

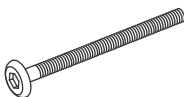

 M6 x 70mm Dx6pcs	 M4 Allen Key Ax1pcs	 M6 Lock Nut Kx6pcs	 M10 Spanner Lx1pcs	 M6 Washer Ix12pcs	 M6 Spring Washer Nx6pcs
---	--	---	---	--	--

5 Zoned Slat System - Double Size/ 135cm x 190cm

Our unique zonal slat system targets and supports you where it matters for a perfect night's sleep. Offering upper and lower body support, spinal alignment and pressure relief, this slat system is responsive, comfortable, and perfect for all body types.

Diagram 3

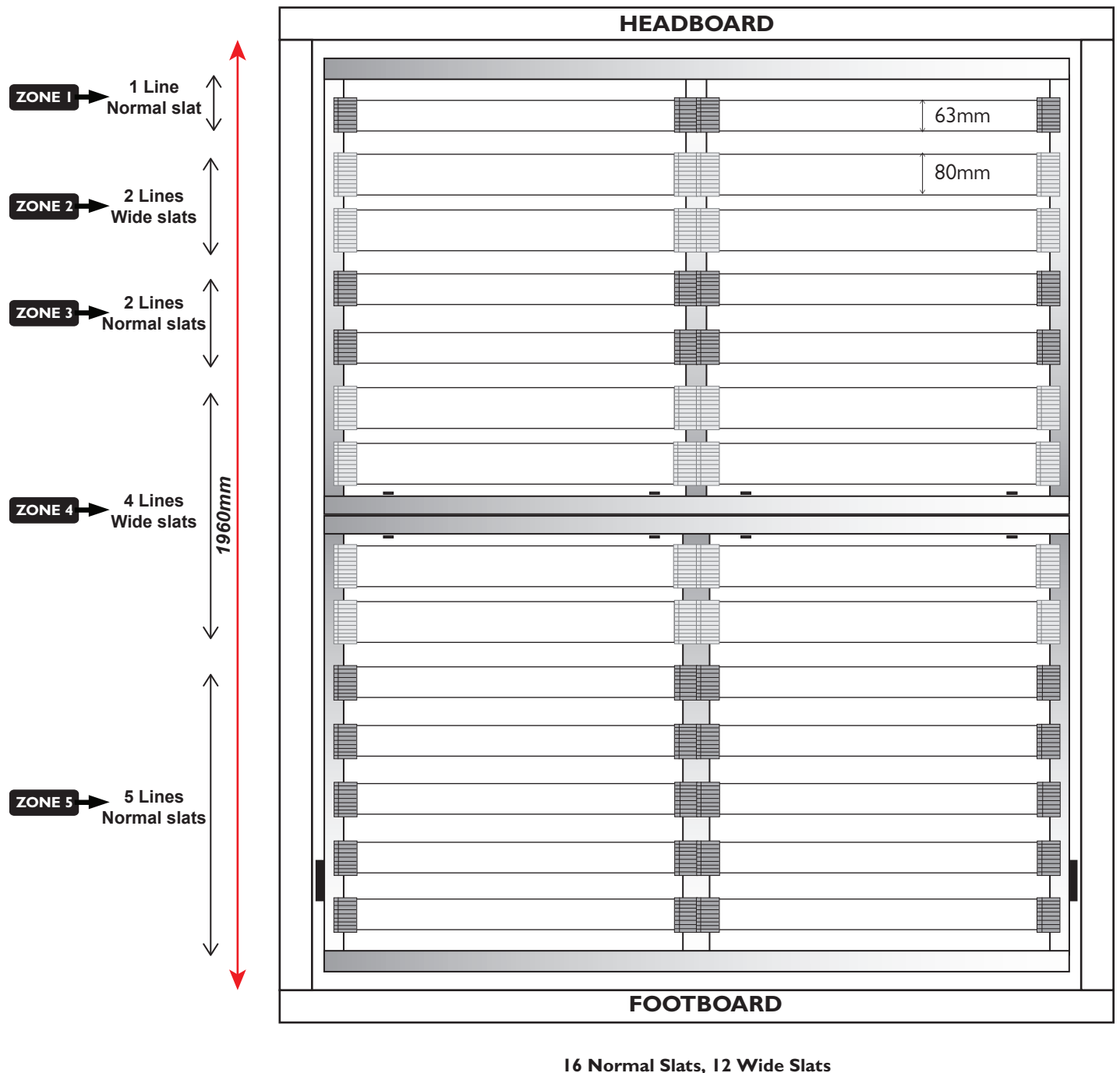

5 Zoned Slat System - King Size/ 150cm x 200cm & Super King/ 180cm x 200cm

Our unique zonal slat system targets and supports you where it matters for a perfect night's sleep. Offering upper and lower body support, spinal alignment and pressure relief, this slat system is responsive, comfortable, and perfect for all body types.

Diagram 4

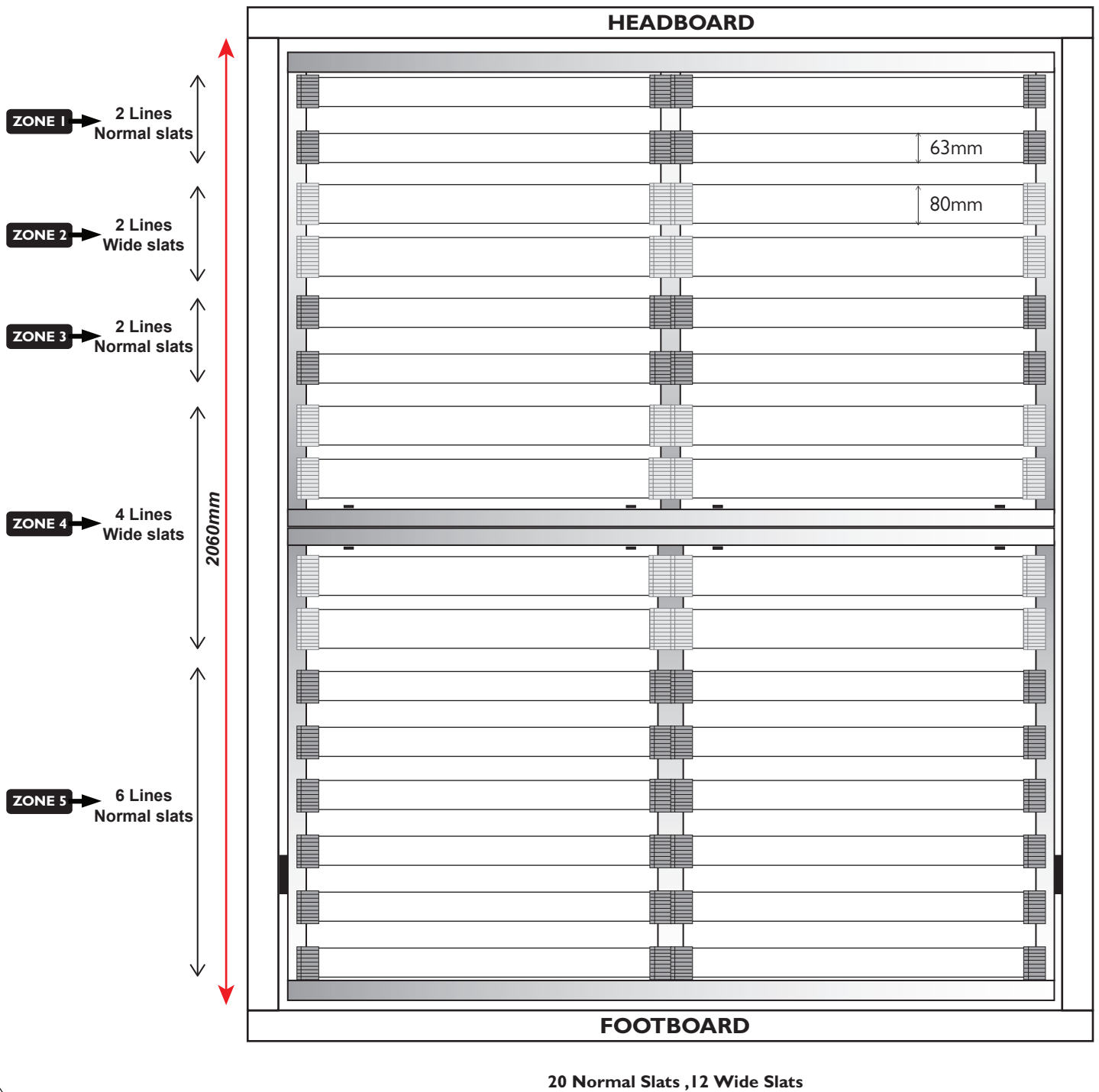

Step 6

Follow diagram 3 or 4, to arrange the slats in the correct sequence and keep the rest the same.

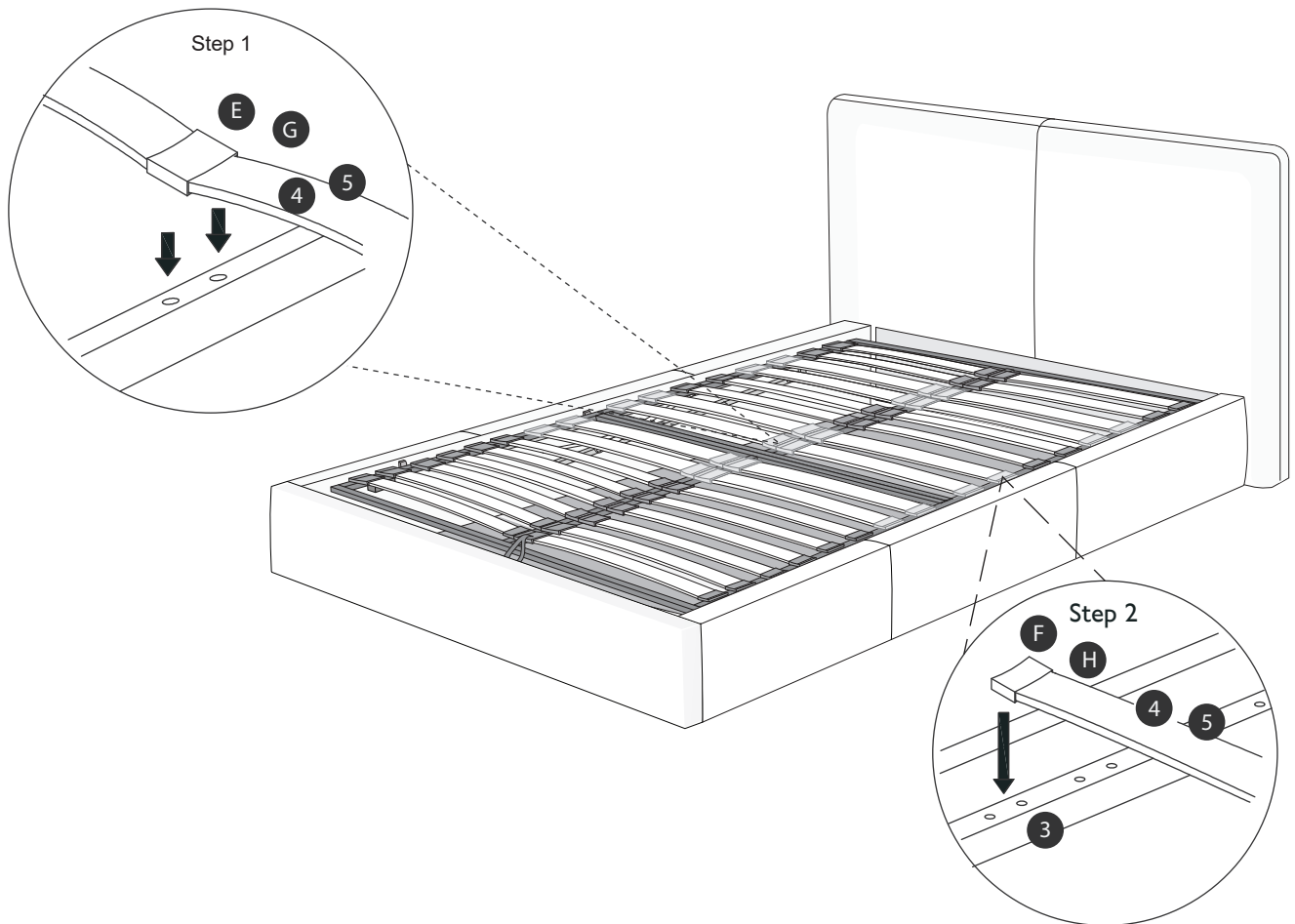
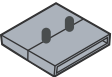

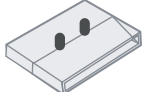
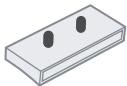
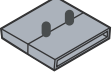

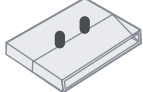
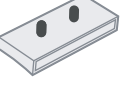

Fig. 1



Insert the slats into the holders at an angle sliding the corner into the cap first. Carefully insert one corner of the slat into the holder (Fig.1) and then slide in the rest of the slat to form a firm fit.

<p>Double /135cm</p>	 Centre Caps Ex8pcs	 Side Caps Fx16pcs	 Wide Centre Slat Caps Gx6pcs	 Wide Side Slat Caps Hx12pcs
<p>King /150cm Super King/180cm</p>	 Centre Caps Ex10pcs	 Side Caps Fx20pcs	 Wide Centre Slat Caps Gx6pcs	 Wide Side Slat Caps Hx12pcs

Step 7

Attach the hydraulic piston to the metal base. Check all fixings are fully tightened. Carefully lift the whole base and attach the other end of the position to the metal arm using the M8 Hexagonal Nut and secure in place with M13 Spanner (M).

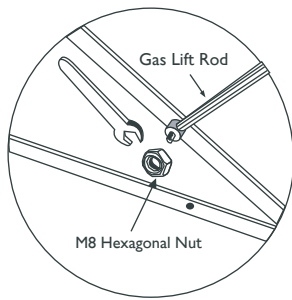

Use the string handle to lift-up the metal frame only

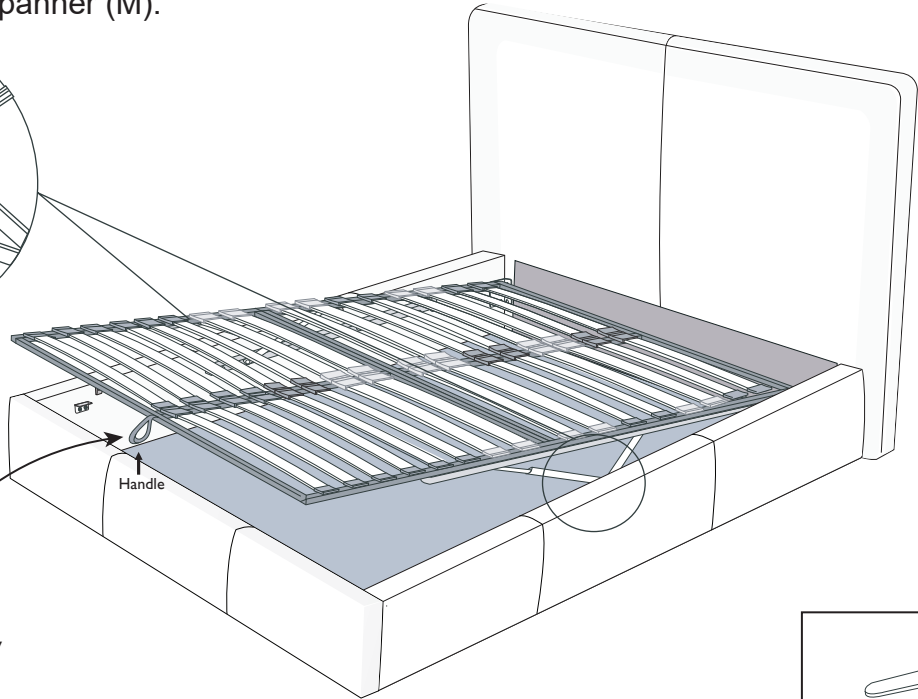

M13 Spanner
Mx1pcs

Step 8

Attach the Felt Pad (O) to each of the support brackets to help prevent noise when using your product. The bed is now ready to use: Please place your mattress on the bed before operating the lift.

*Felt pad (O) provided to secure the metal frame from direct contact with the bracket

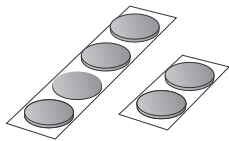

Step to install Felt pad:

- 1- Clean the surface
- 2- Peel, stick on the surface and press tightly to secure it place

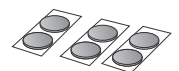
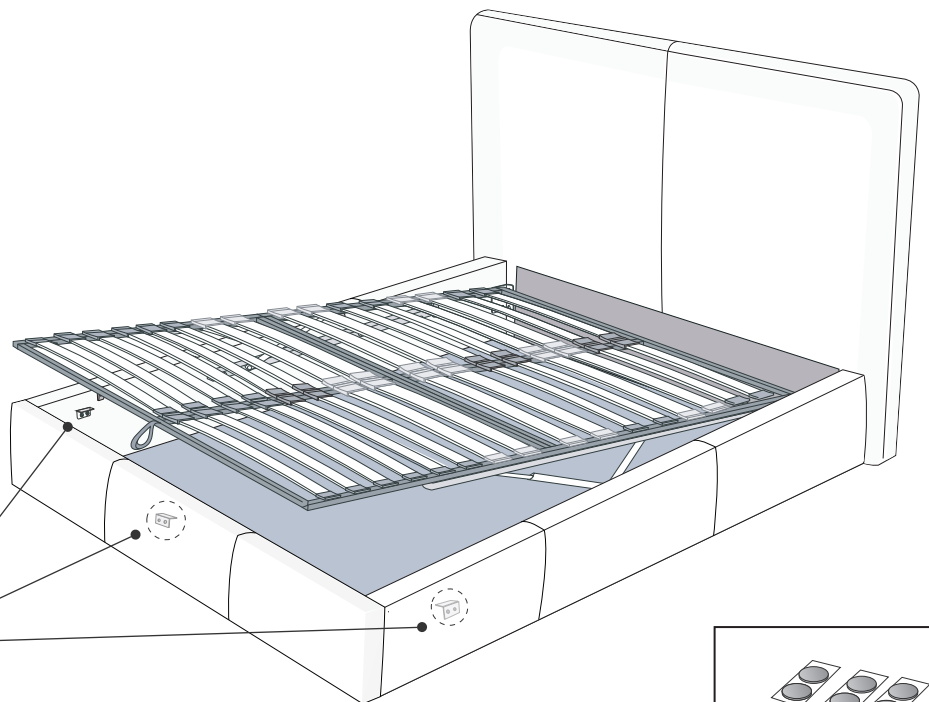
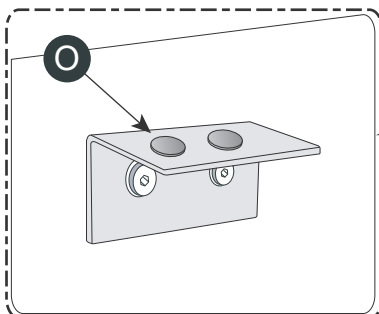

Felt Pad
Ox6pcs

PLACE YOUR MATTRESS ON THE BED BEFORE OPERATING THE LIFT.

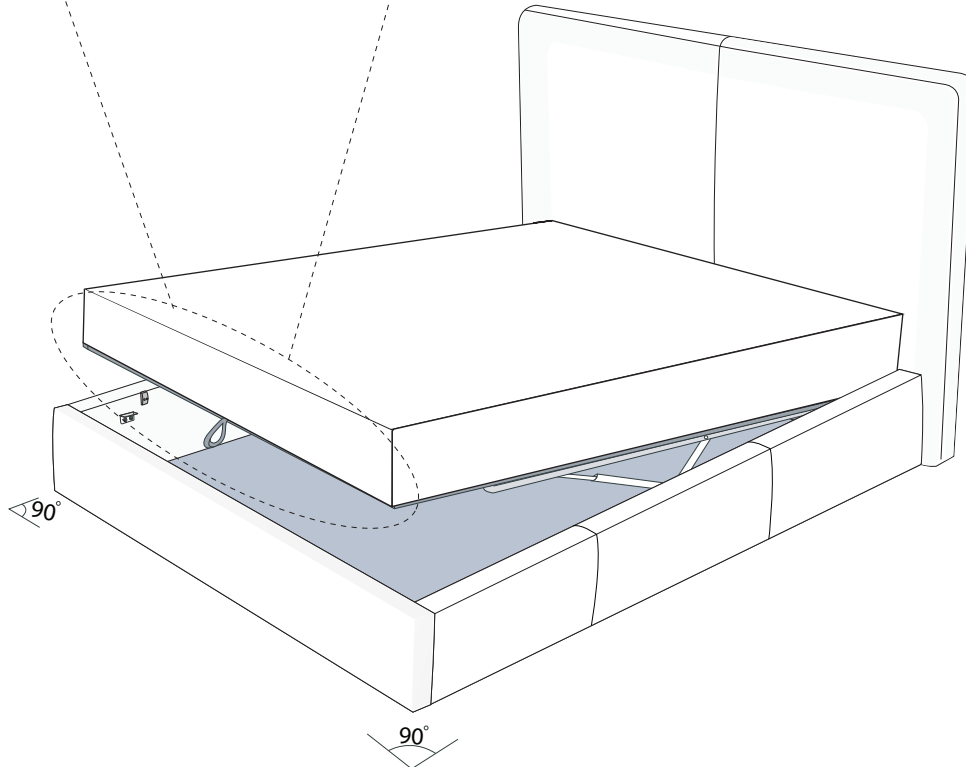
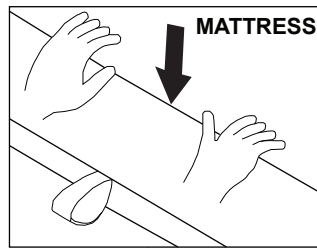
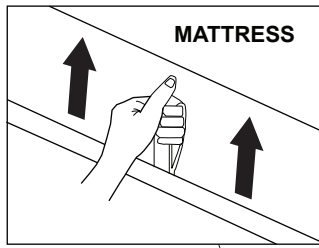

IMPORTANT NOTICE

1. Make sure the bed corners are always square at 90 degrees before closing the sleeping base.
2. Always use handle to lift the metal base.
3. Always use both hands to lower down the metal base.
4. The mattress must be fitted to the base in order for it to close. Always open or close the base from a central position. Never attempt to operate from a corner or side position.
5. Do not operate the Lift Up Mechanism without the mattress fitted to the base.

Caution: Please be aware, if the mattress is removed the lift up base may lift up on its own.

“IMPORTANT NOTICE”

- PLEASE DO NOT ALLOW CHILDREN OR PETS INSIDE THE STORAGE AREA.
- PLEASE BE CAREFUL WHEN LIFTING.
ONLY LIFTING WITH MATTRESS ON TOP.
TO BE OPERATED BY ADULTS ONLY.
- PLEASE DO NOT PRESS DOWN ON THE MATTRESS WHEN THE BED FRAME IS IN THE UP POSITION.
- THE BED FRAME MUST BE ONLY CLOSED BY USING BOTH HANDS.